



晶采光電科技股份有限公司  
AMPIRE CO., LTD.

## SPECIFICATIONS FOR LCD MODULE

<b>CUSTOMER</b>	
<b>CUSTOMER PART NO.</b>	
<b>AMPIRE PART NO.</b>	<b>AM-1024768J2TZQW-00H</b>
<b>APPROVED BY</b>	
<b>DATE</b>	

- Preliminary Specification  
 Formal Specification

**AMPIRE CO., LTD.**

**Building A, 4F., No.116, Sec. 1, Sintai 5th Rd., Xizhi Dist,  
New Taipei City 221, Taiwan (R.O.C.)**

**新北市汐止區新台五路一段 116 號 4 樓(東方科學園區 A 棟)**

**TEL:886-2-26967269 , FAX:886-2-26967196 or 26967270**

APPROVED BY	CHECKED BY	ORGANIZED BY
Patrick	Jessica	Mantle

\*This Specification is subject to change without notice.

## RECORD OF REVISION

Revision Date	Page	Contents	Editor
2020/01/06	--	New Release	Mantle
2020/04/29	4, 18	Update Operation temperature	Tank
2020/08/06	6	Update LED Life Time	Tank

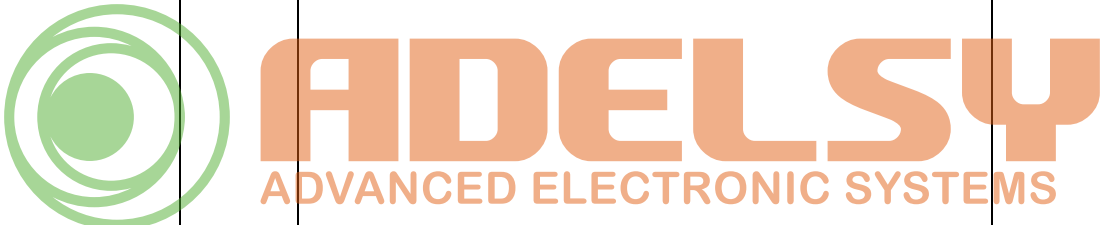

## 1. Features

8 inch Amorphous-TFT-LCD (Thin Film Transistor Liquid Crystal Display) module. This module is composed of a 8" TFT-LCD panel and LED backlight and LED driving board.

- (1) Construction: 8" a-Si TFT active matrix, White LED Backlight.
- (2) Resolution (pixel): 1024(R.G.B) X 768
- (3) Number of the Colors : 16.7M colors ( R , G , B 8 bit digital each)
- (4) LCD type :SFT with Normally Black

## 2. PHYSICAL SPECIFICATIONS

Item	Specifications	unit
LCD size	8 inch (Diagonal)	
Resolution	1024 x (RGB) x 768	dot
Pixel pitch	0.158(H) x 0.158(V)	mm
Active area	162.05(W) x 121.54(H)	mm
Module size	183.43(W) x 138.35(H) x 3.75(D)	mm
Color arrangement	RGB-stripe	
Contrast Ratio	1800:1	
Brightness	1000	cd/m <sup>2</sup>
Driver IC	RM51150+HX8684B	

### 3. ABSOLUTE MAX. RATINGS

#### 3.1 TFT Absolute Maximum Ratings

Item	Symbol	Values		UNIT	Note
		Min.	Max.		
Power voltage	VCC	-0.3	5.0	V	Note1
	AVDD	-0.5	13.5		Base on IC Spec
	VGH	-0.3	42		
	VGL	VGH-42	0.3		
	VCOM	2.75	4.75		Base on Test
Operation temperature	TOP	-20	75	°C	
Storage temperature	TST	-30	80	°C	
Relative Humidity Note 2	RH	--	≤95	%	Ta≤40°C
		--	≤85	%	40°C<Ta≤50°C
		--	≤55	%	50°C<Ta≤60°C
		--	≤36	%	60°C<Ta≤70°C
		--	≤24	%	70°C<Ta≤80°C
Absolute Humidity	AH	--	≤70	g/m <sup>3</sup>	Ta>70°C

Note1: Input voltage include RxIN0±, RxIN1±, RxIN2± and RxCLKI±.

Note2: Ta means the ambient temperature.

It is necessary to limit the relative humidity to the specified temperature range.

Condensation on the module is not allowed.

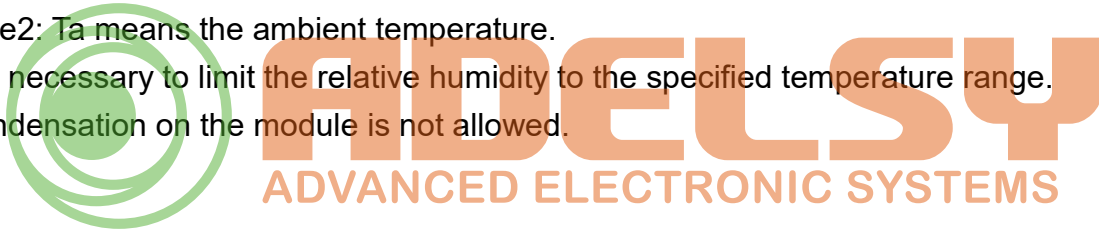

## 4. ELECTRICAL CHARACTERISTICS

### 4-1 Typical Operation Conditions

AGND=GND=0V, Ta=25°C

Item	Symbol	Min	Typ.	Max	Unit	Remark
Digital Supply Voltage	DVDD	3	3.3	3.6	V	-
Analog Supply Voltage	AVDD	12.4	12.6	12.8	V	-
Gate On Voltage	VGH	22	23	24	V	-
Gate Off Voltage	VGL	-7.5	-7	-6.5	V	-

### 4-2 Power Consumption

AGND=GND=0V, Ta=25°C

Item	Symbol	Condition	Min	Typ.	Max	Unit	Remark
Digital Supply Current	IVCC	DVDD=3.3V	-	TBD	-	mA	-
Analog Supply Current	IAVDD	AVDD=12.6V	-	TBD	-	mA	-
Gate On Current	IVGH	VGH=23.0V	-	TBD	-	mA	-
Gate Off Current	IVGL	VGL=-7.0V	-	TBD	-	mA	-
Power Consumption	Pane I & Gamma		-	TBD	-	mW	-

Note1: Checkered Black pattern for Typ.



**ADELSY**  
ADVANCED ELECTRONIC SYSTEMS

### 4-3 LED Driving Conditions

Item	Symbol	Values			Unit	Note
		Min.	Typ.	Max.		
LED voltage	$V_F$	21.6	TBD.	28	V	Note(1)
LED forward Current	$I_F$	--	180	--	mA	$T_a=25^{\circ}\text{C}$
LED Life Time	--	--	30	--	Khr	$T_a=25^{\circ}\text{C}$

Note (1) The constant current source is needed for white LED back-light driving.

$I_F=180\text{mA}$

Note (2) Brightness to be decreased to 50% of the initial value.  $T_a=25^{\circ}\text{C}$

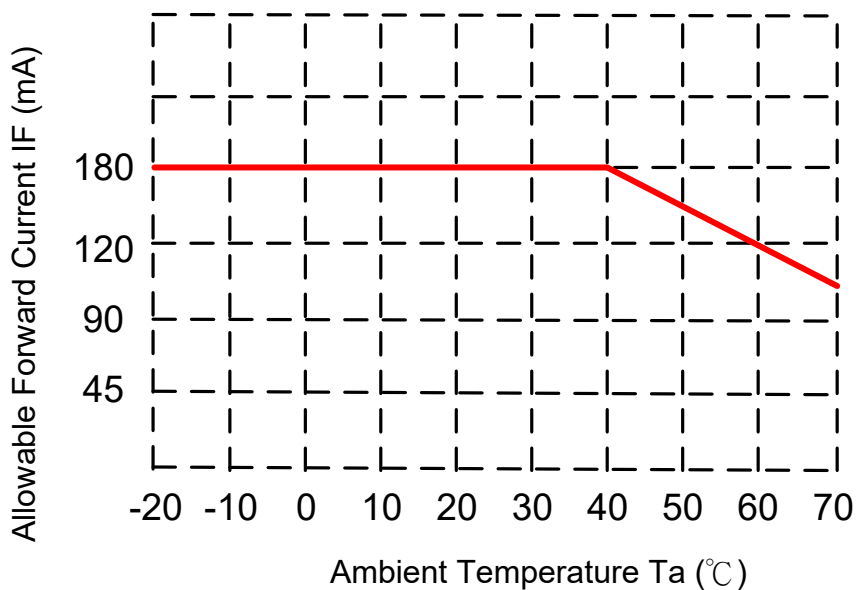
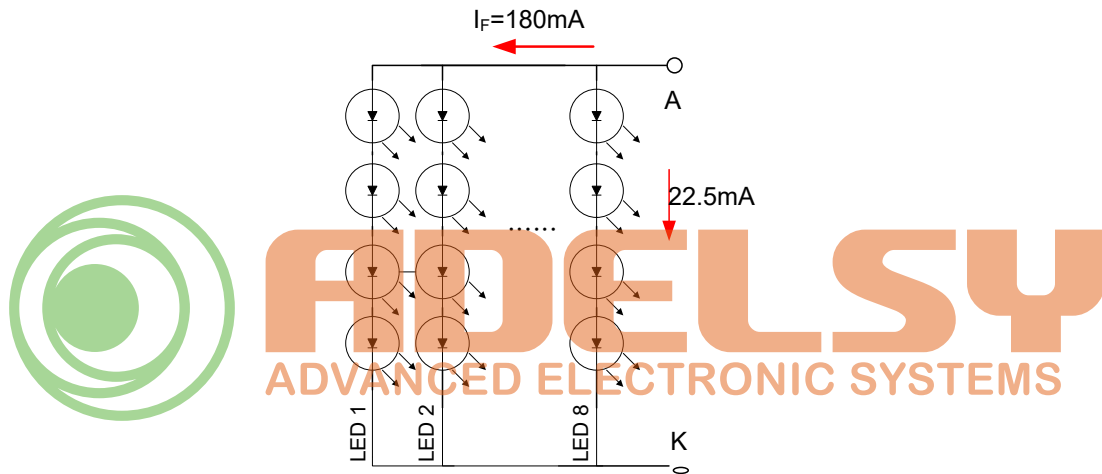

#### 4-4 Block Diagram

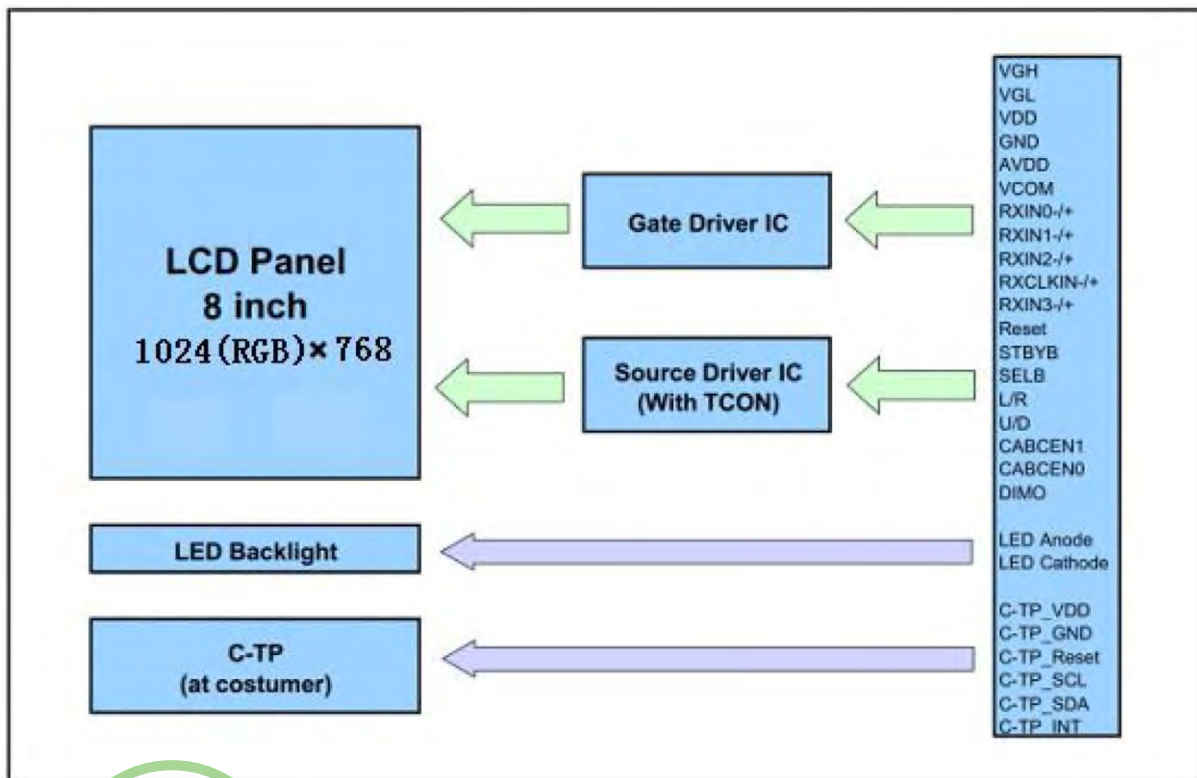

**ADELSY**  
ADVANCED ELECTRONIC SYSTEMS

## 5. Timing Chart

### 5.1 AC Electrical Characteristics

Parameter	Symbol	Min	Typ.	Max	Unit	Conditions
Clock Frequency	$R_{x\text{FCLK}}$	20	–	71	MHz	
Input data skew margin	$T_{\text{RSKM}}$	–	–	500	ps	$ \text{VID} =400\text{mV}$ , $R_{\text{XVCM}}=1.2\text{V}$ $R_{\text{XFCLK}}=71\text{MHz}$
Clock high time	$T_{\text{LVCH}}$	–	$4/(7 * R_{x\text{FCLK}})$	–	ns	
Clock low time	$T_{\text{LVCL}}$	–	$3/(7 * R_{x\text{FCLK}})$	–	ns	
PLL wake-up time	$T_{\text{enPLL}}$	–	–	150	us	

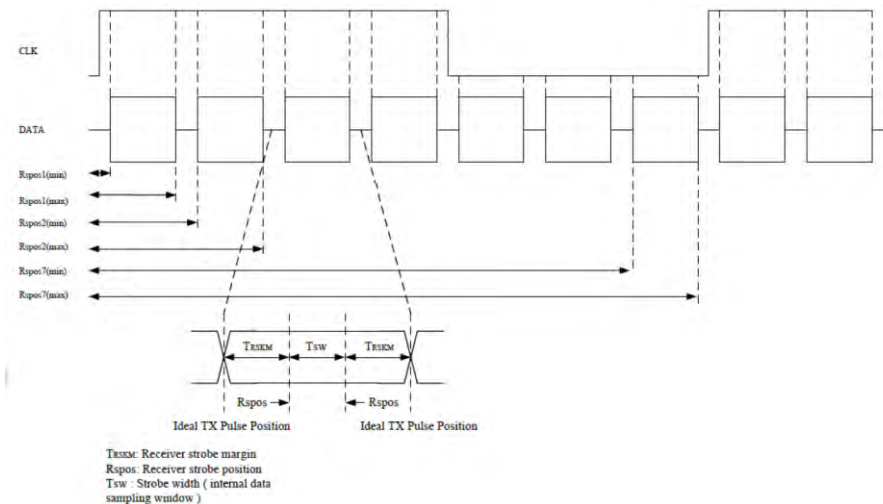
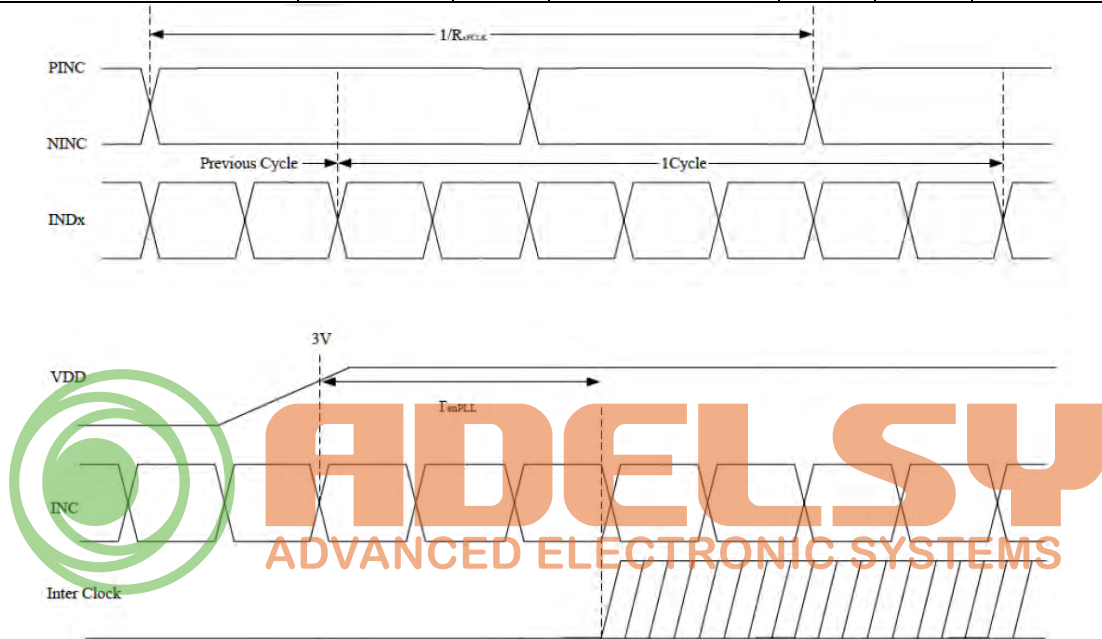

Parameter	Symbol	Min	Typ.	Max	Unit	Conditions
Modulation Frequency	$\text{SSC}_{\text{MF}}$	23	-	93	kHz	
Modulation Rate	$\text{SSC}_{\text{MR}}$	-	-	+/-3	%	LVDS spread clock=71MHz center



## 5.2 DC Electrical Characteristics

Parameter	Symbol	Min	Typ.	Max	Unit	Remark
Differential input high Threshold voltage	$R_{XVTH}$	-	-	0.2	V	$R_{XVCM}=1.2V$
Differential input Low Threshold voltage	$R_{XVTL}$	-0.2	-	-	V	
Input voltage range (singled-end)	$R_{XVIN}$	0	-	$VDD-1.2$	V	
Differential input common mode voltage	$R_{XVCM}$	$ V_{ID} /2$	-	$VDD-1.2- V_{ID} /2$	V	
Differential input voltage	$ V_{ID} $	0.2	-	0.6	V	
Differential input leakage Current	$R_{V_{XliZ}}$	-10	-	10	$\mu A$	
LVDS Digital Operating Current	$I_{ddlvds}$	-	15	30	mA	$F_{clk}=65MHz, VDD=3.3V$
LVDS Digital Stand-by Current	$I_{stlvds}$	-	10	50	$\mu A$	Clock & all functions are stopped

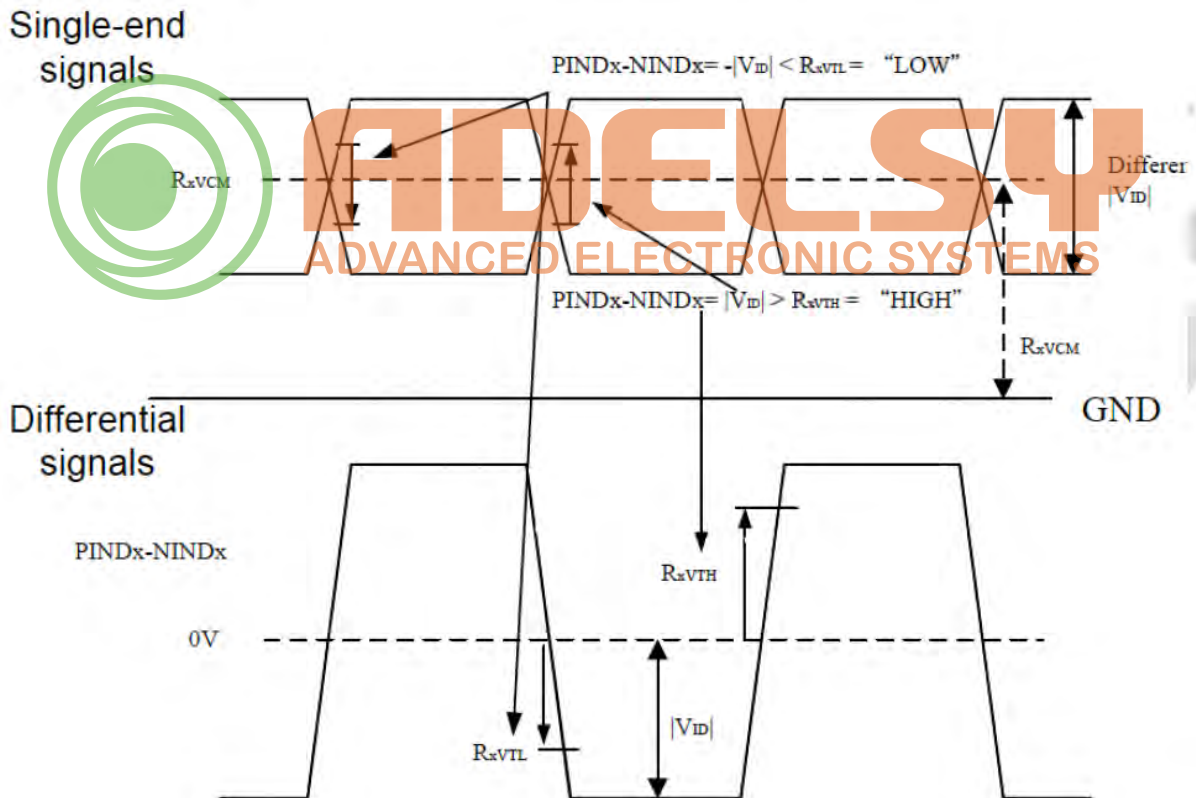

### 5.3 Data input format

#### 5.3.1 LVDS data mapping

6-bit LVDS input (SELB= "H" )

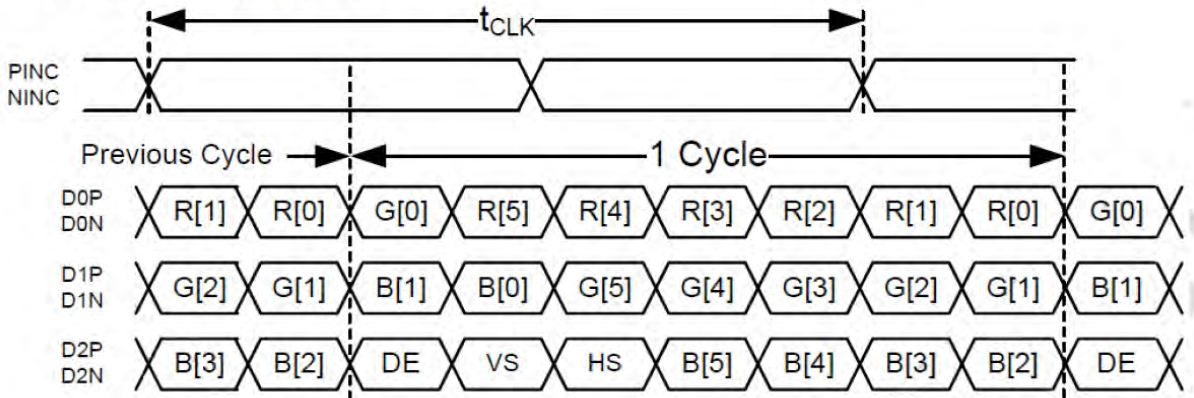

8-bit LVDS input (SELB= "L" )

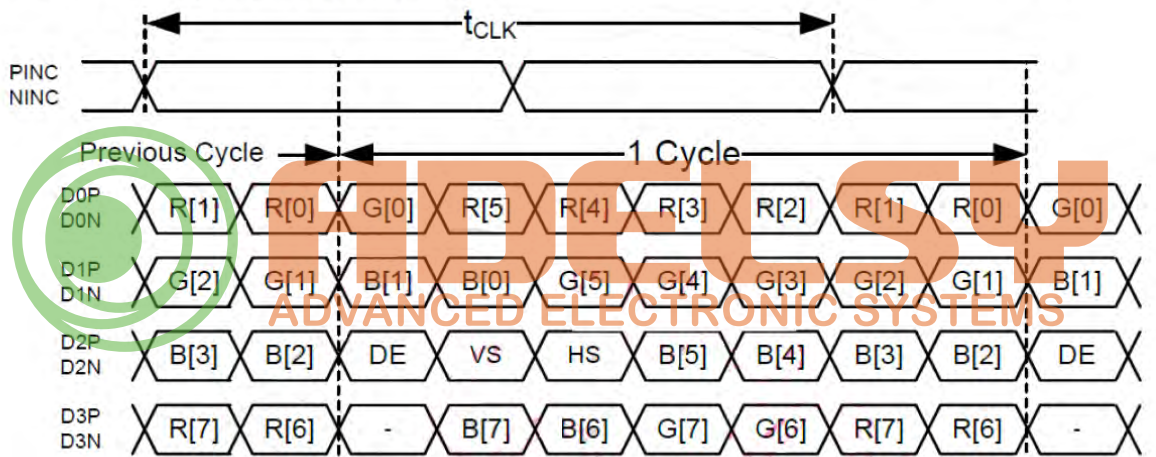

#### 5.3.2 Parallel RGB input timing table

- DE mode

Parameter	Symbol	Value			Unit
		Min.	Typ.	Max.	
DCLK frequency	fclk	52	65	71	MHz
Horizontal Display Area	thd	1024			DCLK
HSD Period	th	1114	1344	1400	DCLK
HSD Blanking	thb+thfp	90	320	376	DCLK
Vertical display area	tvd	768			T <sub>H</sub>
VSD period	tv	778	806	845	T <sub>H</sub>
VSD Blanking	tvbp+tvfp	10	38	77	T <sub>H</sub>

**DE mode(1024x768)**

## 5.4 Power ON/OFF Sequence

Item	Symbol	Min	Typ.	Max	Unit
VDD on to Reset signal	T1	1	-	-	ms
Reset to Standby off	T2	0	-	-	
Standby off to Display signal on	T3	1	-	-	
Display signal to AVDD on	T4	33.2	-	-	
AVDD on to VGL on	T5	16.6	-	-	
VGL on to VGH on	T6	16.6	-	-	
VGH on to B/L on	T7	200	-	-	
B/L off to Standby on	T8	500	-	-	
Standby on to VGL off	T9	33.2	-	-	
VGL off to VGH off	T10	16.6	-	-	
VGH off to AVDD off	T11	16.6	-	-	
AVDD off to Display signal off	T12	16.6	-	-	
Display signal off to VDD and Reset off	T13	16.6	-	-	

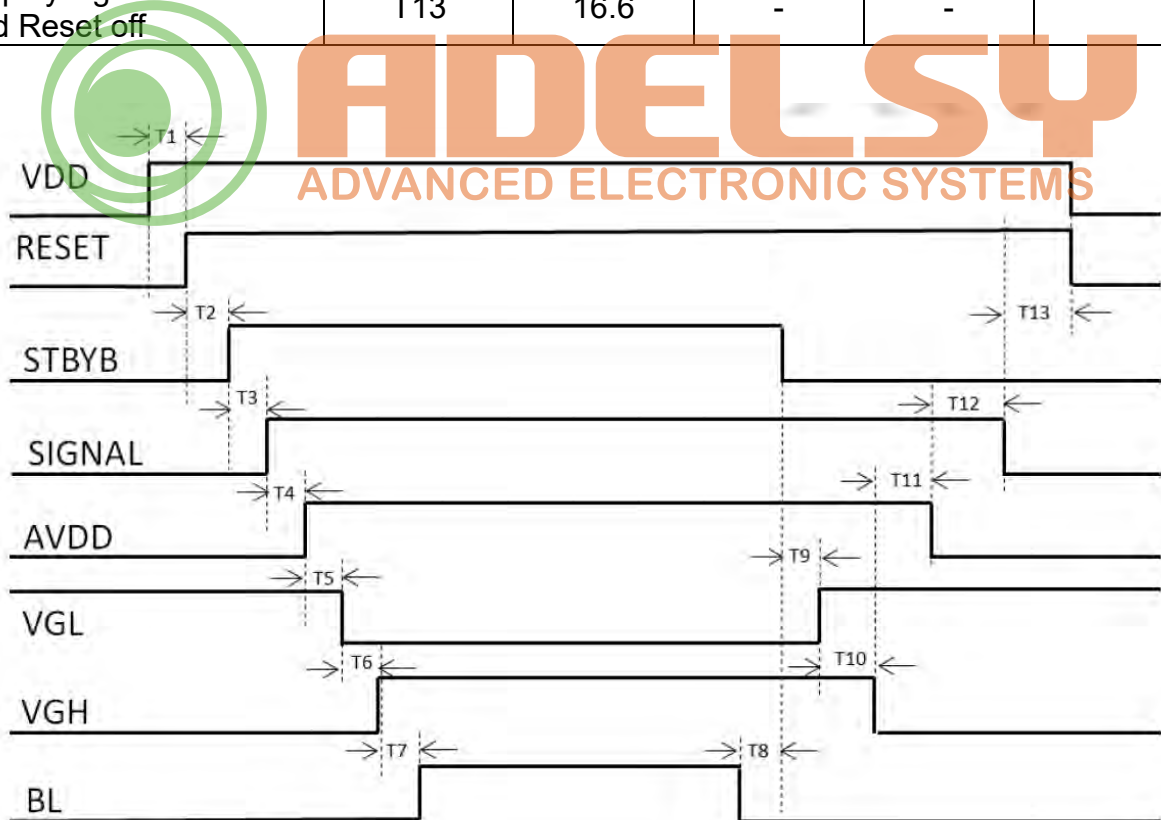

## 6. Optical Specifications

### 6.1 TFT Optical Characteristics

Item	Symbol	Condition	Min	Typ	Max	Unit	Remark
View Angles	$\theta T$	$CR \geq 10$	75	85	-	Degree	Note 2
	$\theta B$		75	85	-		
	$\theta L$		75	85	-		
	$\theta R$		75	85	-		
Contrast Ratio	CR	$\theta = 0^\circ$	1500	1800	-		Left/right $0^\circ$ Top/bottom $5^\circ$
Response Time	$T_{ON}$	$25^\circ C$	-	35	45	ms	Note1 · Note4
	$T_{OFF}$						
Chromaticity	White	x	-0.05	0.310	+0.05		Note1 · Note5
		y		0.329			
	Red	x		0.587			
		y		0.330			
	Green	x		0.358			
		y		0.586			
	Blue	x		0.156			
		y		0.098			
Uniformity	U		80	85	-	%	Note1 · Note6
NTSC			45	50	-	%	
Luminance	L		800	1000	-	cd/m <sup>2</sup>	Note7

Test Conditions:

1.  $I_F = 180mA$ , the ambient temperature is  $25^\circ C$ .
2. The test systems refer to Note 1 and Note2.

Note 1 : Definition of optical measurement system.

The optical characteristics should be measured in dark room. After 30 minutes operation, the optical properties are measured at the center point of the LCD screen. (Response time is measured by Photo detector TOPCON BM-7, other items are measured by BM-5A/Field of view : 1° / Height : 500mm.)

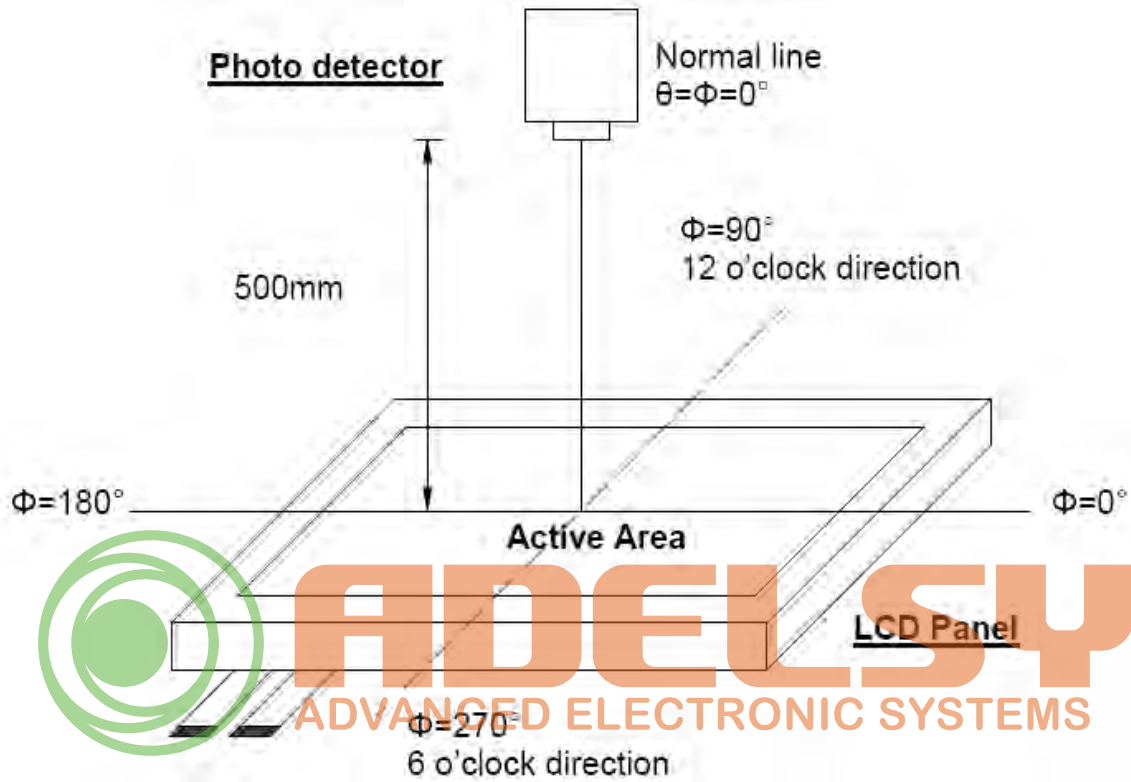

Note 2 : Definition of viewing angle range

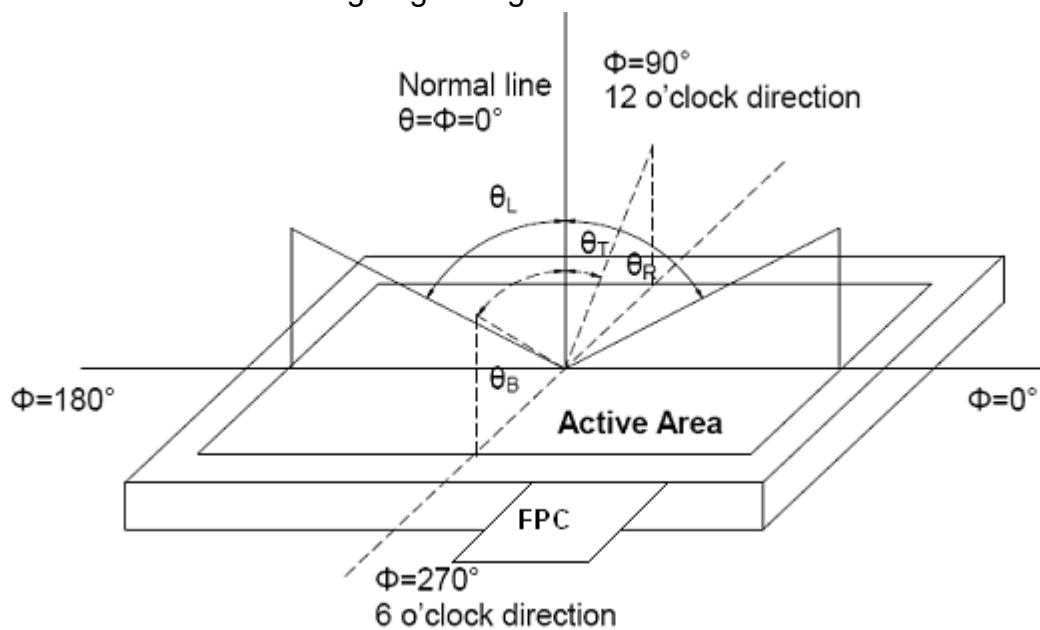

Note 3 : Definition of Response time

The response time is defined as the LCD optical switching time interval between “White” state and “Black” state. Rise time ( $T_{ON}$ ) is the time between photo detector output intensity changed from 90% to 10%. And fall time ( $T_{OFF}$ ) is the time between photo detector output intensity changed from 10% to 90%.

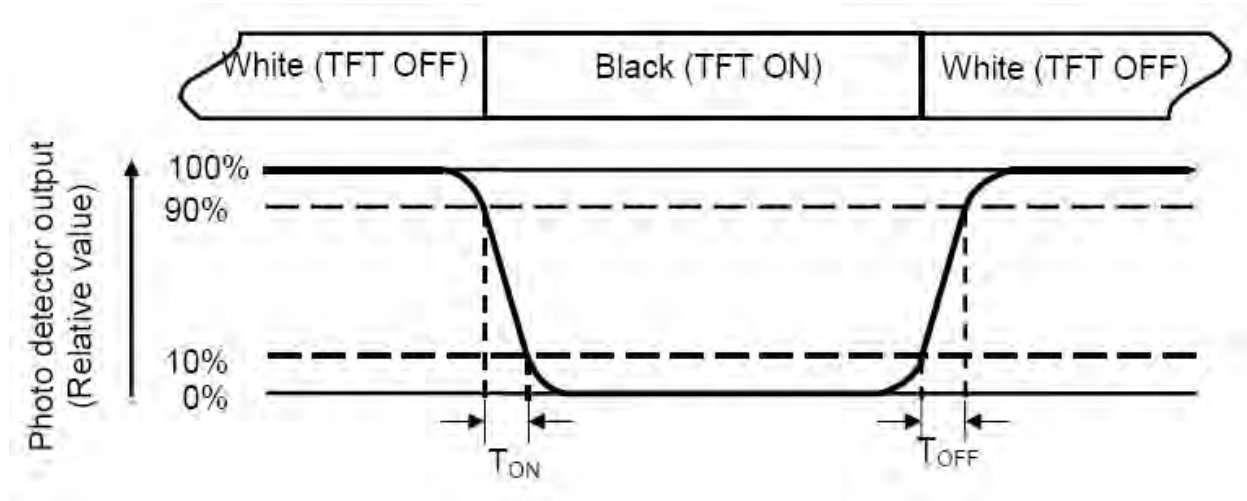

Note 4 : Definition of contrast ratio

$$\text{Contrast Ratio (CR)} = \frac{\text{Luminance measured when LCD on the "White" state}}{\text{Luminance measured when LCD on the "Black" state}}$$

Note 5 : Definition of color chromaticity (CIE1931)

Color coordinated measured at center point of LCD.

Note 6 : All input terminals LCD panel must be ground when measuring the center area of the panel.

Note 7 : Definition of Luminance Uniformity

Active area is divided into 9 measuring areas (Refer to bellow figure). Every measuring point is placed at the center of each measuring area.

$$\text{Luminance Uniformity}(Y_u) = \frac{B_{min}}{B_{max}}$$

L ----- Active area length      W ----- Active area width

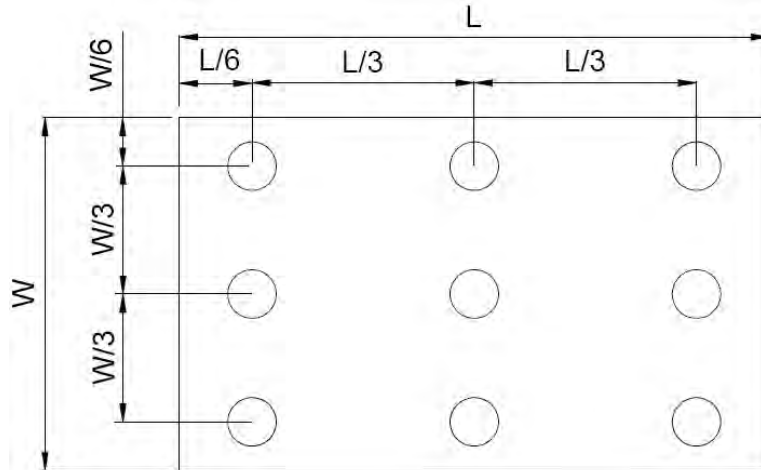

B<sub>max</sub> : The measured maximum luminance of all measurement position.

B<sub>min</sub> : The measured minimum luminance of all measurement position.



## 6. INTERFACE

Pin No	Symbol	I/O	Function	Remark
1	NC	-	No connection	
2	VDD	P	Power Voltage for digital circuit	
3	VDD	P	Power Voltage for digital circuit	
4	NC	---	No connection	
5	Reset	I	Global reset pin	
6	STBYB	I	Standby mode, Normally pulled high STBYB = "1", normal operation STBYB = "0", timing controller, source driver will turn off, all output are GND	
7	GND	P	Ground	
8	RXIN0-	I	- LVDS differential data input	
9	RXIN0+	I	+ LVDS differential data input	R[0]~G[0]
10	GND	P	Ground	
11	RXIN1-	I	- LVDS differential data input	
12	RXIN1+	I	+ LVDS differential data input	G[1]~B[1]
13	GND	P	Ground	
14	RXIN2-	I	- LVDS differential data input	
15	RXIN2+	I	+ LVDS differential data input	DE/VS/HS/ B[2]~B[5]
16	GND	P	Ground	
17	RXCLKIN-	I	- LVDS differential clock input	
18	RXCLKIN+	I	+ LVDS differential clock input	
19	GND	P	Ground	
20	RXIN3-	I	- LVDS differential data input	
21	RXIN3+	I	+ LVDS differential data input	R[6]/R[7]/ G[6]/G[7]/ B[6]/ B[7]
22	GND	P	Ground	
23	NC	---	No connection	
24	NC	---	No connection	
25	GND	P	Ground	
26	NC	---	No connection	
27	DIMO	O	Backlight CABC controller signal output	Note1
28	SELB	I	6bit/8bit mode select No	Note2
29	AVDD	P	Power for Analog Circuit	
30	GND	P	Ground	
31	LED-	P	LED Cathode	
32	LED-	P	LED Cathode	
33	L/R	I	Horizontal inversion	Note3



34	U/D	I	Vertical inversion N	Note3
35	VGL	P	Gate OFF Voltage	
36	CABCEN1	I	CABC H/W enable pin	Note4
37	CABCEN0	I	CABC H/W enable pin	Note4
38	VGH	P	Gate ON Voltage	
39	LED+	P	LED Anode	
40	LED+	P	LED Anode	

I/O----definition, I----Input, O----Output, P----Power, No used I/O pin please fix to GND level

Note1: PWM output after CABC function;

Note2: LVDS mode 6bits/8bits input select pin. If LVDS input data in 6 bits, SELB must be set to high. If LVDS input data in 8 bits, SELB must be set to low.

Note3: When L/R="0", set right to left scan direction, L/R="1" set left to right scan direction. When U/D="0", set top to bottom scan direction, U/D="1" set bottom to top scan direction.

Note4:

CABC\_EN【1 : 0】 CABC H/W enable pin. Normally pull low.

CABC\_EN="00", CABC off. (Default mode)

CABC\_EN="01", user interface image.

CABC\_EN="10", still picture.

CABC\_EN="11", moving image.

## 7. RELIABILITY TEST CONDITIONS

Test Item	Test Conditions	Note
High Temperature Operation	75±3°C , t=240 hrs	
Low Temperature Operation	-20±3°C , t=240 hrs	
High Temperature Storage	80±3°C , t=240 hrs	1,2
Low Temperature Storage	-30±3°C , t=240 hrs	1,2
Thermal Shock Test	-30°C ~ 80°C 30 min. ~ 30 min. ( 1 cycle ) Total 100cycle	1,2
Storage Humidity Test	60 °C, Humidity 90%, 240 hrs	1,2
Vibration Test (Packing)	Sweep frequency : 10 ~ 50 ~ 10 Hz/1min Amplitude : 0.75mm Test direction : X.Y.Z/3 axis Duration : 30min/each axis	2

Note 1: Condensation of water is not permitted on the module.

Note 2: The module should be inspected after 1 hour storage in normal conditions (15-35°C, 45-65%RH).

Note 3 : The module shouldn't be tested more than one condition, and all the test conditions are independent.

Note 4 : All the reliability tests should be done without protective film on the module.

Definitions of life end point:

- Current drain should be smaller than the specific value.
- Function of the module should be maintained.
- Appearance and display quality should not have degraded noticeably.
- Contrast ratio should be greater than 50% of the initial value.

## 8. General Precautions

### 8.1 Handling Precautions

1. Display panel is made of glass. Do not subject it to a mechanical shock by dropping it from a high place, etc.
2. If the display panel is damaged and the liquid crystal substance inside it leaks out, be sure not to get any in your mouth, if the substance comes into contact with your skin or clothes, promptly wash it off using soap and water.
3. Do not apply excessive force to the display surface or the adjoining areas since this may cause the color tone to vary.
4. The polarizer covering the display surface of the LCD module is soft and easily scratched. Handle this polarizer carefully.
5. If the display surface is contaminated, breathe on the surface and gently wipe it with a soft dry cloth. If still not completely clear, moisten cloth with one of the following solvents:
  - Isopropyl alcohol
  - Ethyl alcoholSolvents other than those mentioned above may damage the polarizer. Especially, do not use the following:
  - Water
  - Ketone
  - Aromatic solvents
6. Do not attempt to disassemble the LCD Module.
7. If the logic circuit power is off, do not apply the input signals.
8. To prevent destruction of the elements by static electricity, be careful to maintain an optimum work environment.
  - a. Be sure to ground the body when handling the LCD Modules.
  - b. Tools required for assembly, such as soldering irons, must be properly ground.
  - c. To reduce the amount of static electricity generated, do not conduct assembly and other work under dry conditions.
  - d. The LCD Module is coated with a film to protect the display surface. Be care when peeling off this protective film since static electricity may be generated.

## 8.2 Storage precautions

1. When storing the LCD modules, avoid exposure to direct sunlight or to the light of fluorescent lamps.
2. The LCD modules should be stored under the storage temperature range. If the LCD modules will be stored for a long time, the recommend condition is:  
Temperature : 0°C ~ 40°C  
Relatively humidity: ≤80%
3. The LCD modules should be stored in the room without acid, alkali and harmful gas.

## 8.3 General Precautions

1. Do not keep the LCD at the same display pattern continually. The residual image will happen and it will damage the LCD. Please use screen saver.
2. The LCD modules should be no falling and violent shocking during transportation, and also should avoid excessive press, water, damp and sunshine.

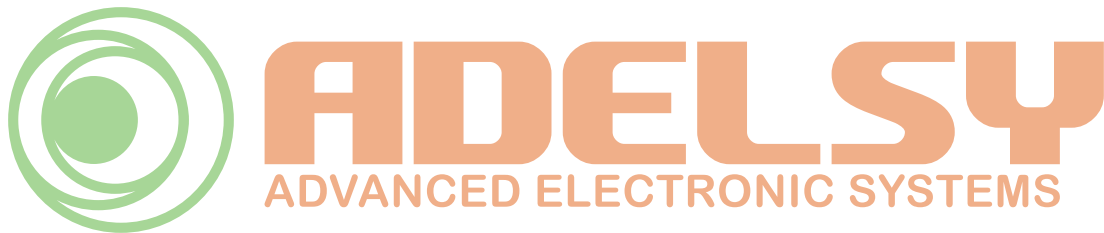

# 9. OUTLINE DIMENSION

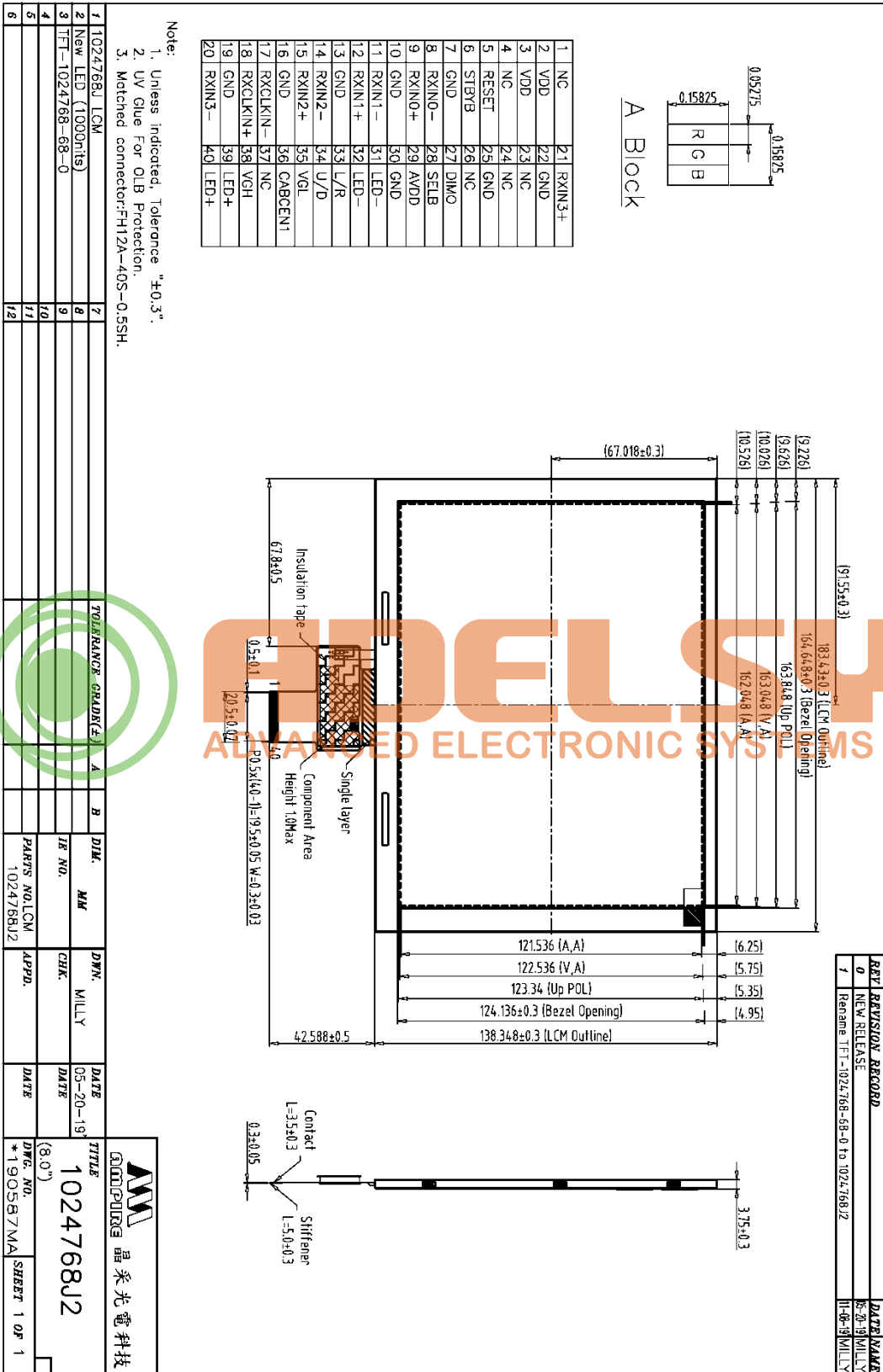

REV	REVISION RECORD	DATE	NAME
0	NEW RELEASE	05-20-19	MILLY
1	Rename TFT-1024768-68-0 to 1024768J2	11-08-19	MILLY

1	NC	21	RXIN3+
2	VDD	22	GND
3	VDD	23	NC
4	NC	24	NC
5	RESET	25	GND
6	STBYB	26	NC
7	GND	27	DIM0
8	RXIN0-	28	SELB
9	RXIN0+	29	AVDD
10	GND	30	GND
11	RXIN1-	31	LED-
12	RXIN1+	32	LED-
13	GND	33	L/R
14	RXIN2-	34	U/D
15	RXIN2+	35	VGL
16	GND	36	CABCEN1
17	RXCLKIN-	37	NC
18	RXCLKIN+	38	VGH
19	GND	39	LED+
20	RXIN3-	40	LED+

Note:  
 1. Unless indicated, Tolerance "+0.3".  
 2. UV Glue For OLB Protection.  
 3. Matched connector:FH12A-40S-0.5SH.

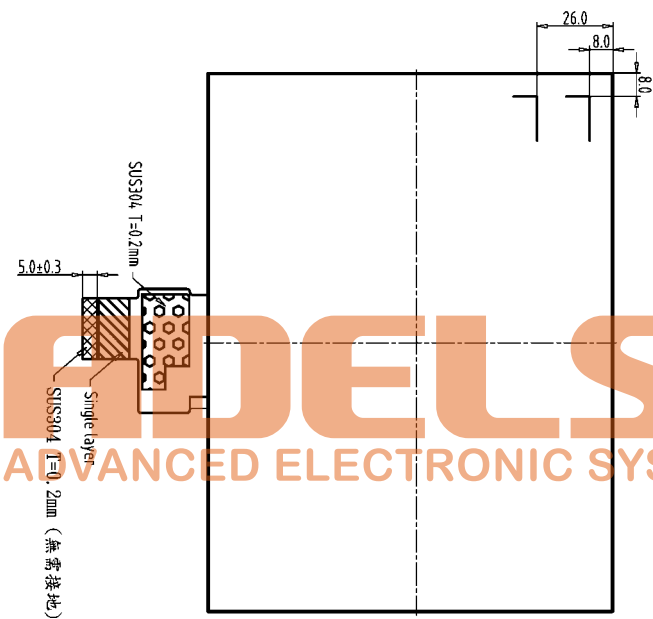

Back View

1	1024768J LCM	7	TOLERANCE GRADY(A)	A	B	DIM.	MM	DRAW.	MILLY	DATE	TITLE
2	New LED (1000units)	8								05-20-19	1024768J2
3	TFT-1024768-68-0	9				TR NO.		CHK.		DATE	(8.0")
4		10				PARTS NO.LCM-1		APPD.		DATE	DWG. NO.
5		11				1024768J2					*190588MA
6		12									SHEET 1 OF 1

